

AvediaPlayer Receivers

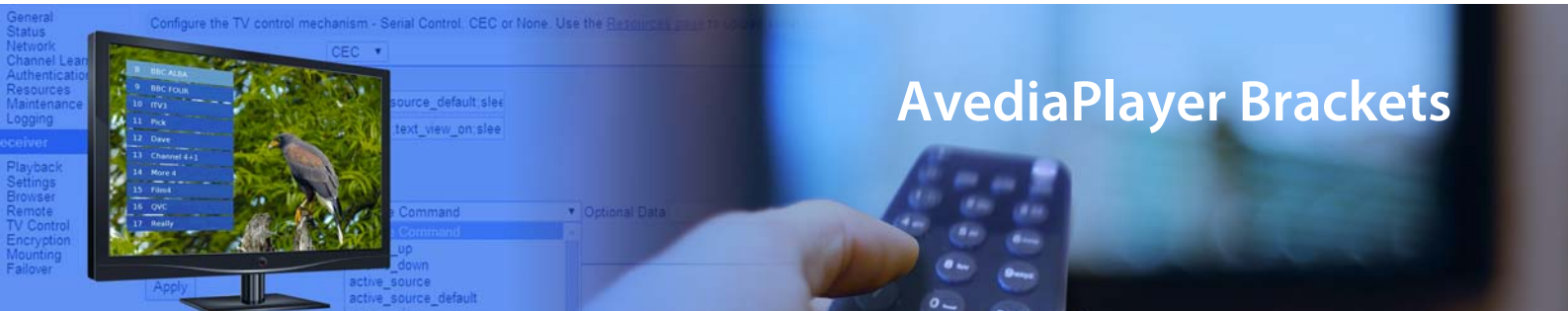

Datasheet



AvediaPlayer Receivers are enhanced by one of our versatile mounting brackets, providing secure installation of the device when the environment requires it.

- Compatible with AvediaPlayer r9300, r9310 and r9220 Receivers
- Under desk mounting option
- Behind screen mounting options provide control of unit and cabling, removing safety hazards they can create

Technical Specifications

Simple Wall Bracket for AvediaPlayer r9300 (avply-smbkt)

- The simple bracket allows an AvediaPlayer r9300 to be mounted on a wall
- Comes with two m2.5 x 4mm screws to attach receiver to bracket

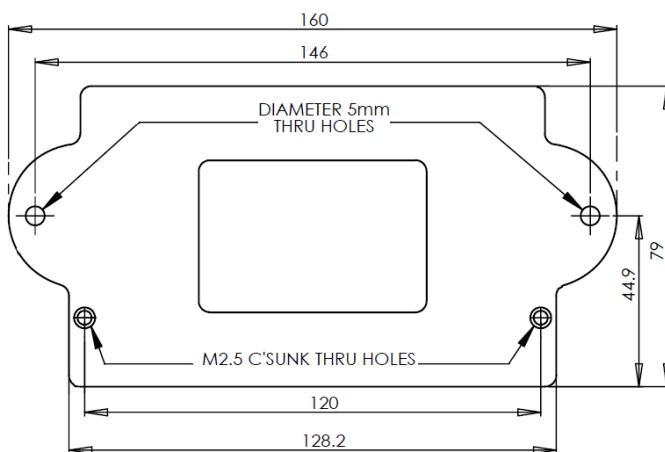

All dimensions in millimeters



Under Desk Mounting Bracket (avply-dbkt)

The under desk mounting bracket can be used with any AvediaPlayer Receiver. Attach the AvediaPlayer unit to the frame and secure under a desk, shelf or to a wall.

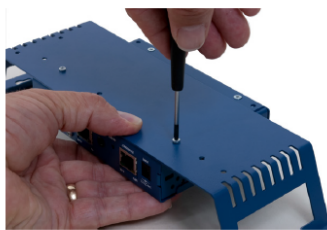
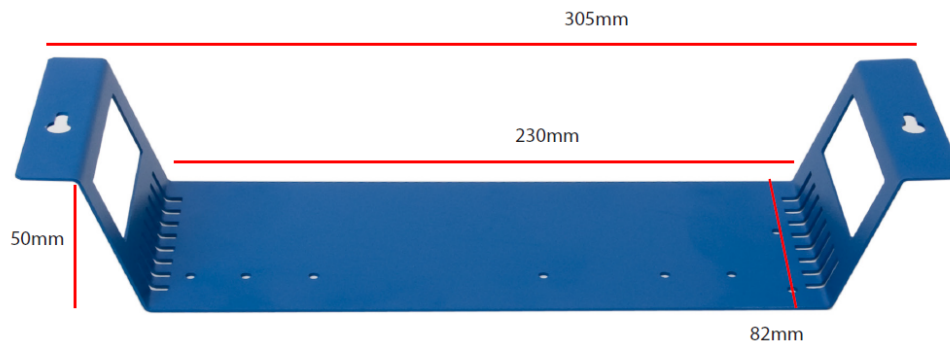

- Bracket works with all AvediaPlayer Receivers
- Comes with four m2.5 x 4mm screws to attach receiver to bracket

Behind Screen Mount - Small Plate Dimensions (avply-vsbt)

This mounting plate allows customers to securely attach any AvediaPlayer Receiver to the back of any standard plasma/LCD mounting options. This small plate allows mounting onto screens less than 32".

- Mounting plate works with all AvediaPlayer Receivers
- Comes with four m2.5 x 4mm screws to attach receiver to plate

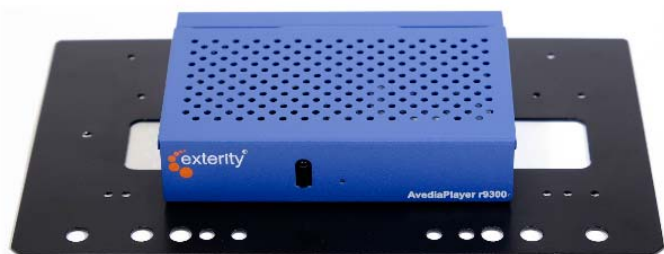
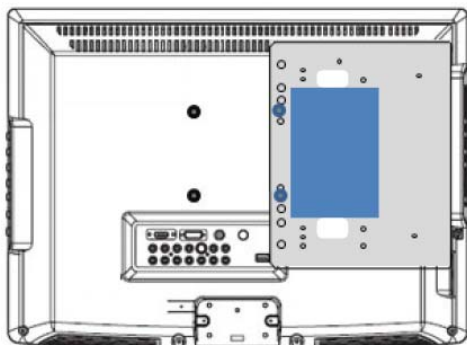
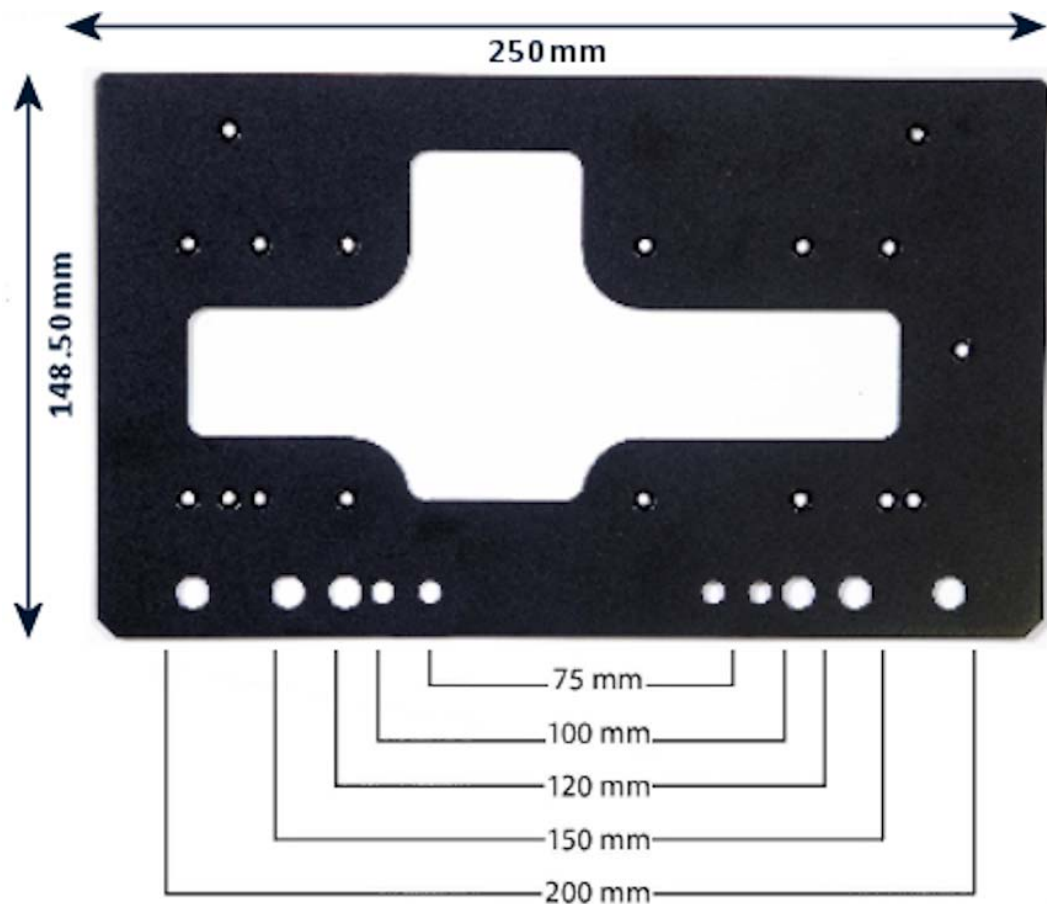

Behind Screen Mount - Large Plate Dimensions (avply-vlbkt)

This mounting plate allows customers to securely attach any AvediaPlayer Receiver to the back of any standard plasma/LCD mounting options. This large plate allows mounting onto screens in excess of 32".

- Mounting plate works with all AvediaPlayer Receivers
- Comes with four m2.5 x 4mm screws to attach receiver to plate

